



TAKIMI cod. 8601 / 8602 / 8603 / 8604 / 8631 / 8632
System /
SCANCARÒ cod. 8831 / 8834 / 8836
Coffee table

Takimi

Family	Armchair / Sofa / Dormeuse / Ottoman / System / Coffee table
Designer	LC Made / 2010
Link	www.read-mo.re/takimi

IT La componibilità è il caposaldo di Takimi di LaCividina, che si è ispirata ai mattoncini del Lego per questi 17 elementi modulari con cui si può creare qualsiasi composizione, dal divano più tradizionale alla seduta più complessa.

EN Modularity is the cornerstone of Takimi by LaCividina, which is inspired by Lego bricks. The 17 modular elements can be used to create anything from the most traditional sofa to the most complex seating.

FR La modularité est le mot-clé de Takimi. LaCividina s'est inspirée des briques Lego lors de la conception de ces 17 éléments modulaires qui permettent de créer n'importe quelle composition, du plus traditionnel canapé à l'assise la plus complexe.

DE Die Kombinierfähigkeit ist der Eckpfeiler des Systems Takimi von LaCividina. Seine 17 modularen Elemente, mit denen eine beliebige Komposition gestaltet werden kann – traditionelle Sofas oder komplexe Sitzgelegenheiten - wurden von den Lego-Bausteinen inspiriert.

TAKIMI cod. 8601 / 8607 / 8610 / 8620 / 8621
System /
UP cod. 8506
Coffee table /
MIL cod. 9096
Coffee table





TAKIMI cod. 8603 / 8604 / 8631 / 8632
System /
SCANCARÒ cod. 8830 / 8831
Coffee table /
UP cod. 8510
Coffee table



TAKIMI cod. 8603 / 8606 / 8608
System /
SCANCARÒ cod. 8830 / 8831
Coffee table /
UP cod. 8512
Coffee table

Dati tecnici · Technical data · Données techniques · Technische Angaben

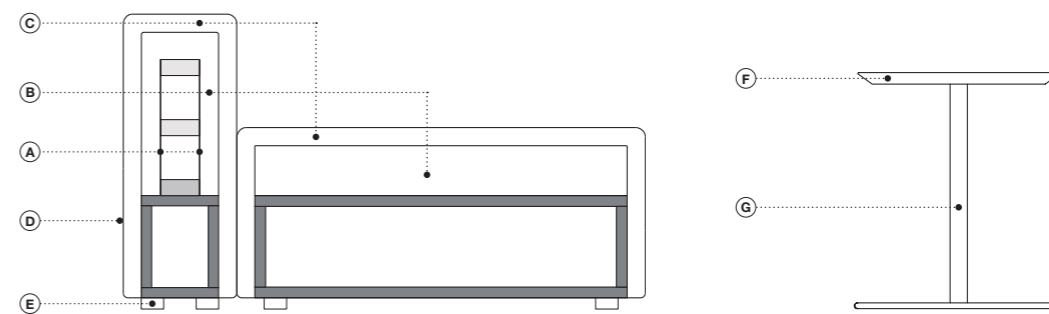

■ Legno massiccio di abete
■ Legno massiccio di faggio
■ Multistrato di faggio

A. Pannello di masonite
B. Poliuretano espanso ignifugo
indeformabile a quote differenziare
C. Fibra di poliestere
D. Rivestimento
E. Polipropilene
F. MDF
G. Acciaio

■ Solid fir
■ Solid beech
■ Multilayered beech

A. Masonite panels
B. Flame-retardant undeformable
polyurethane foam of different
densities
C. Polyester fibers
D. Upholstery
E. Polypropylene
F. MDF
G. Steel

■ Bois de sapin massif
■ Bois de hêtre massif
■ Multiplis de hêtre

A. Panneau de particules
B. Mousse polyuréthane expansé
ignifuge indéformable à épaisseurs
différenciées
C. Fibre de polyester
D. Revêtement
E. Polypropylène
F. MDF
G. Acier

■ Massivholz aus Tanne
■ Massivholz aus Buche
■ Buchenschichtholz

A. Holzfaserplatte
B. Feuerfester formbeständige
Polyurethanschaum in
unterschiedlicher Dichte
C. Polyester
D. Bezug
E. Polypropylen
F. MDF
G. Stahl

Caratteristiche · Features · Caractéristiques · Eigenheiten

· Telaio rinforzato per uso aree pubbliche
· Poliuretano espanso ignifugo
· Poliuretano espanso indeformabile a
quote differenziate ad alta densità
· Cuciture rinforzate con supporto in
fibra di carbonio
· Prodotto disponibile anche su misura

· Reinforced frame for public area use
· Flame-retardant polyurethane foam
· Undeformable polyurethane foam of
different densities
· Reinforced stitching with carbon fiber
support
· This item can be customized

· Structure renforcée pour une utilisation
en espace public
· Mousse polyuréthane expansé ignifuge
· Mousse polyuréthane expansé
indéformable à épaisseurs différenciées
· Coutures renforcées de fibre de carbone
· Produit pouvant être réalisés sur mesure

· Verstärkte Holzstruktur für Nutzung
bei öffentlichem Bereich
· Feuerfester Polyurethanschaum
· Formbeständige Polyurethanschaum
in unterschiedlicher Dichte
· Verstärkte Säume mit Stütz aus
Kohlefaser
· Produkt nach Maß verfügbar

Coordinati · Matching items · Produits assortis · Abgestimmte Produkte



MIL / pag. 420



SCANCARÒ / pag. 434



UP / pag. 448

BOLD /
pag. 464DUOTONE /
pag. 468

Finiture piano tavolo · Tables top finishes · Finitions de plateau de table · Tischplatten Ausführungen



MDF Bianco (RAL 9016)
MDF White (RAL 9016)
MDF Blanc (RAL 9016)
MDF Weiß (RAL 9016)



MDF Nero (RAL 9005)
MDF Black (RAL 9005)
MDF Noir (RAL 9005)
MDF Schwarz (RAL 9005)

Finiture base tavolo · Tables base finishes · Finitions de piètement de tables · Tischgestell Ausführungen



Cromato lucido
Polished chrome
Chromé brillant
Chrom poliert



Nero (RAL 9005)
Black (RAL 9005)
Noir (RAL 9005)
Schwarz (RAL 9005)



Bianco (RAL 9016)
White (RAL 9016)
Blanc (RAL 9016)
Weiß (RAL 9016)

cod. 8601 / seat

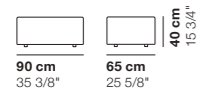

cod. 8602 / seat

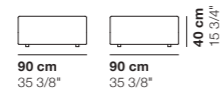

cod. 8603 / seat

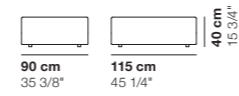

cod. 8604 / seat

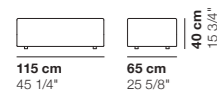

cod. 8605 / seat

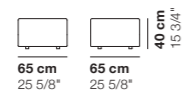

cod. 8606 / seat

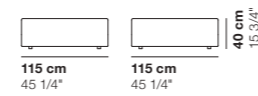

cod. 8607 / seat

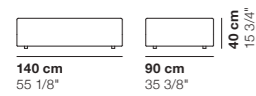

cod. 8608 / seat

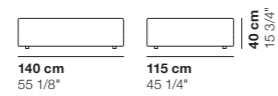

cod. 8610 / seat

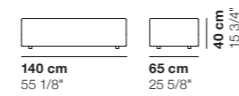

cod. 8620 / back_arm 25

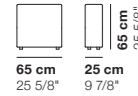

cod. 8621 / back_arm 25

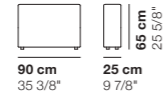

cod. 8622 / back_arm 25

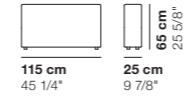

cod. 8623 / back_arm 25

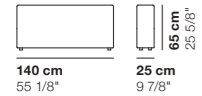

cod. 8630 / back_arm 40

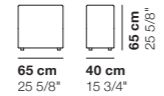

cod. 8631 / back_arm 40

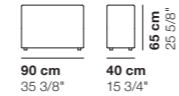

cod. 8632 / back_arm 40

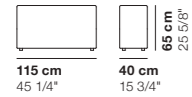

cod. 8633 / back_arm 40

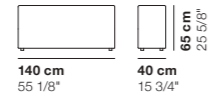

cod. 8640 / coffee table



cod. TAK01 / composition

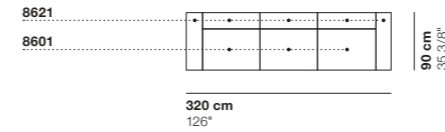

cod. TAK02 / composition

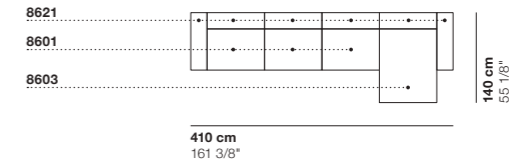

cod. TAK03 / composition

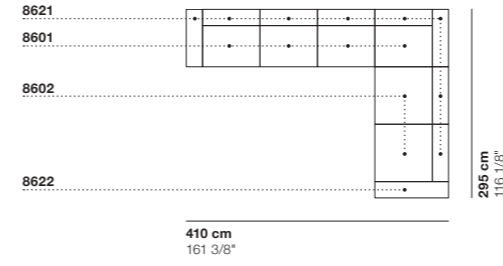

cod. TAK04 / composition

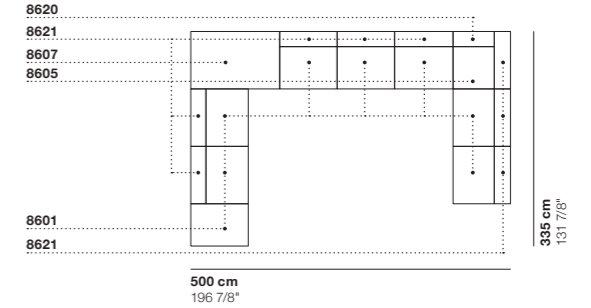

cod. TAK05 / composition

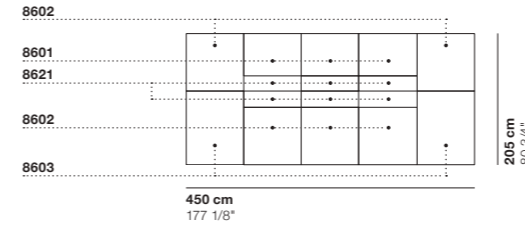

cod. TAK06 / composition

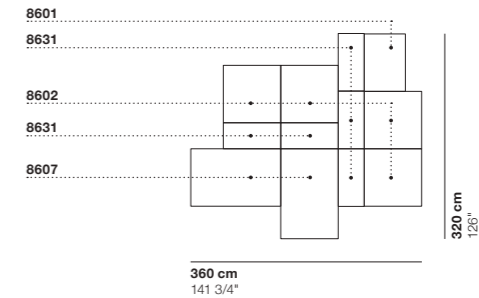

cod. TAK07 / composition

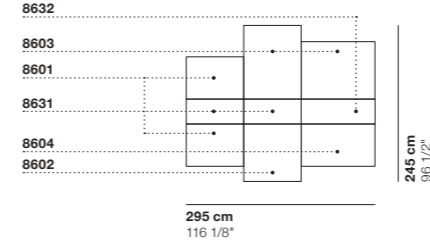

cod. TAK08 / composition

